

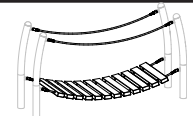

CC

	DocID		QTY	Name
1	78601011		1	Kakum Canopy Walk
2	78601015		1	Cheddar Gorge
3	78601023		1	Megellan Straits
4	78601027		1	Bermuda Triangle
5	PCBOL 200		1	Stepping Bollard
6	PCBOL 300		5	Stepping Bollard
7	PCBOL 400		4	Stepping Bollard

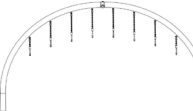
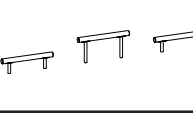
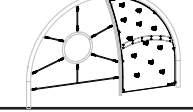

S6

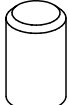
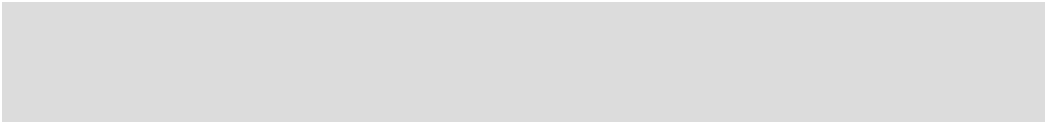
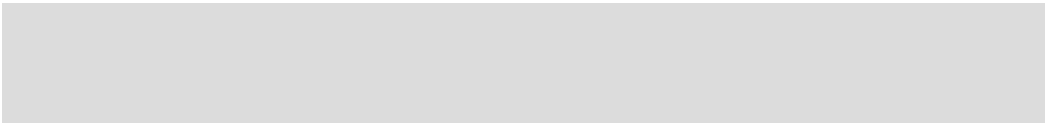
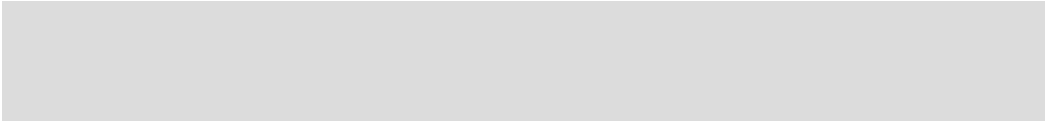
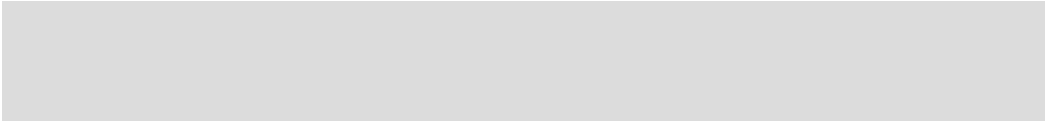
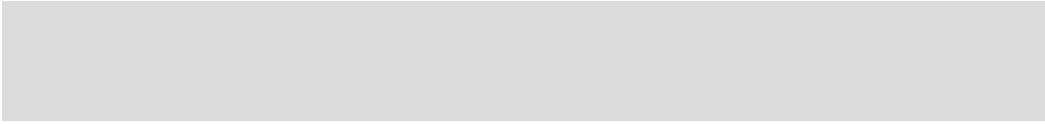
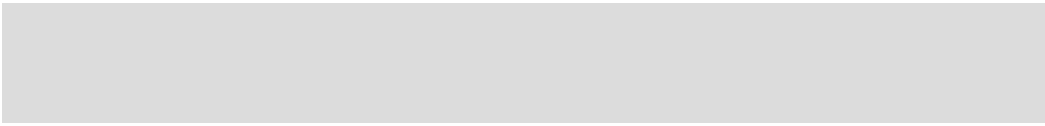
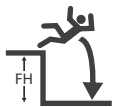

EN1176
2.4m

! 260329

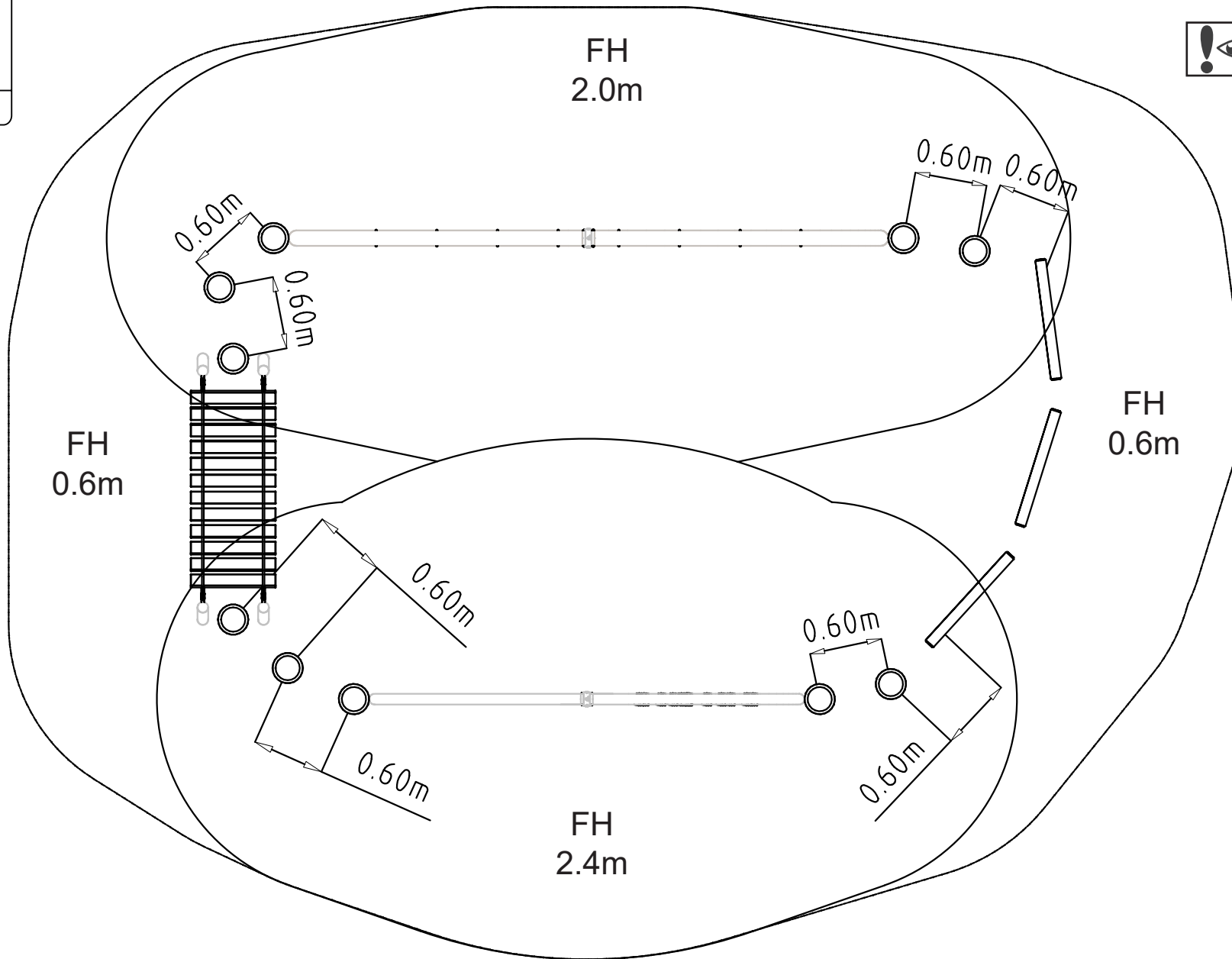

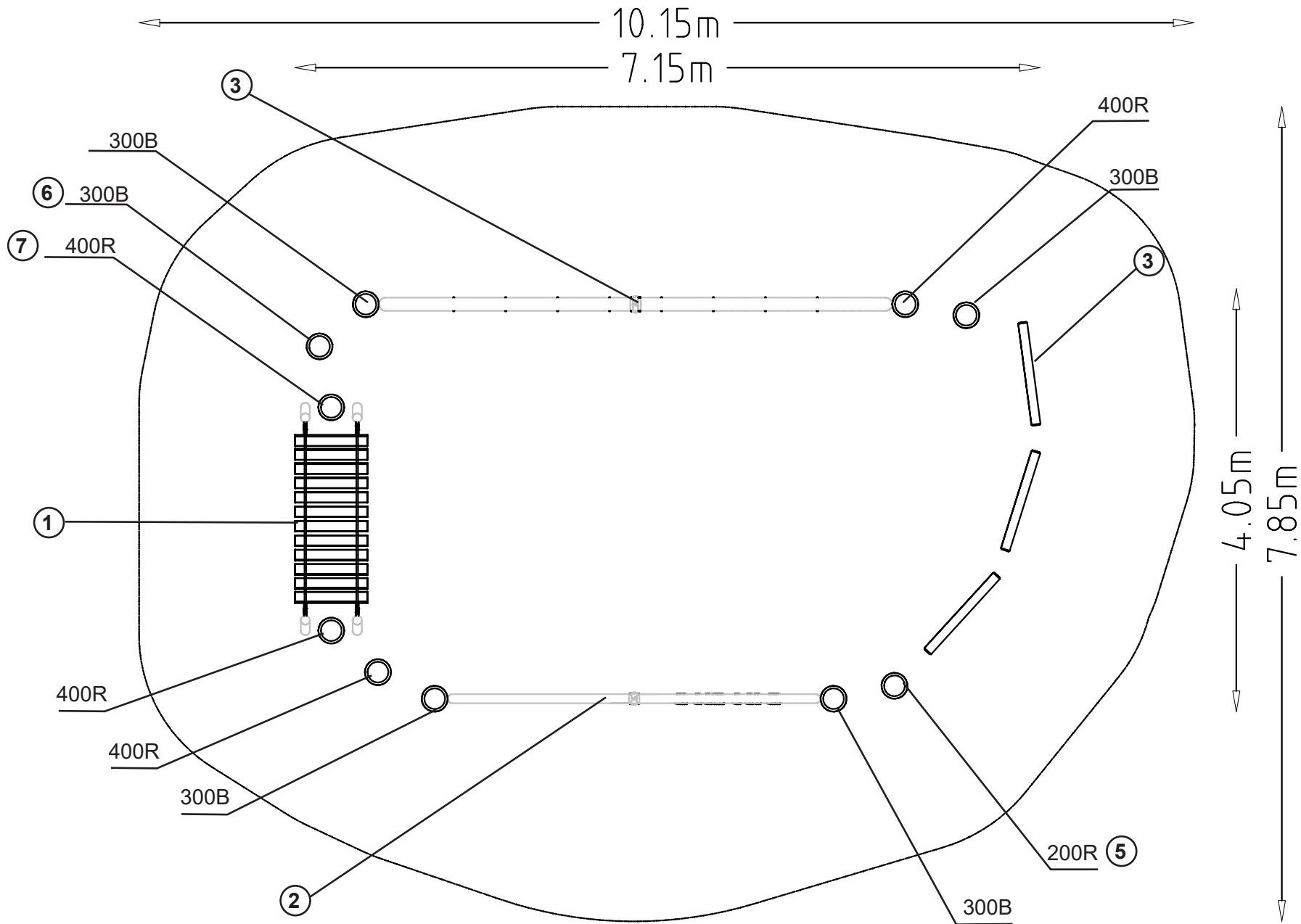

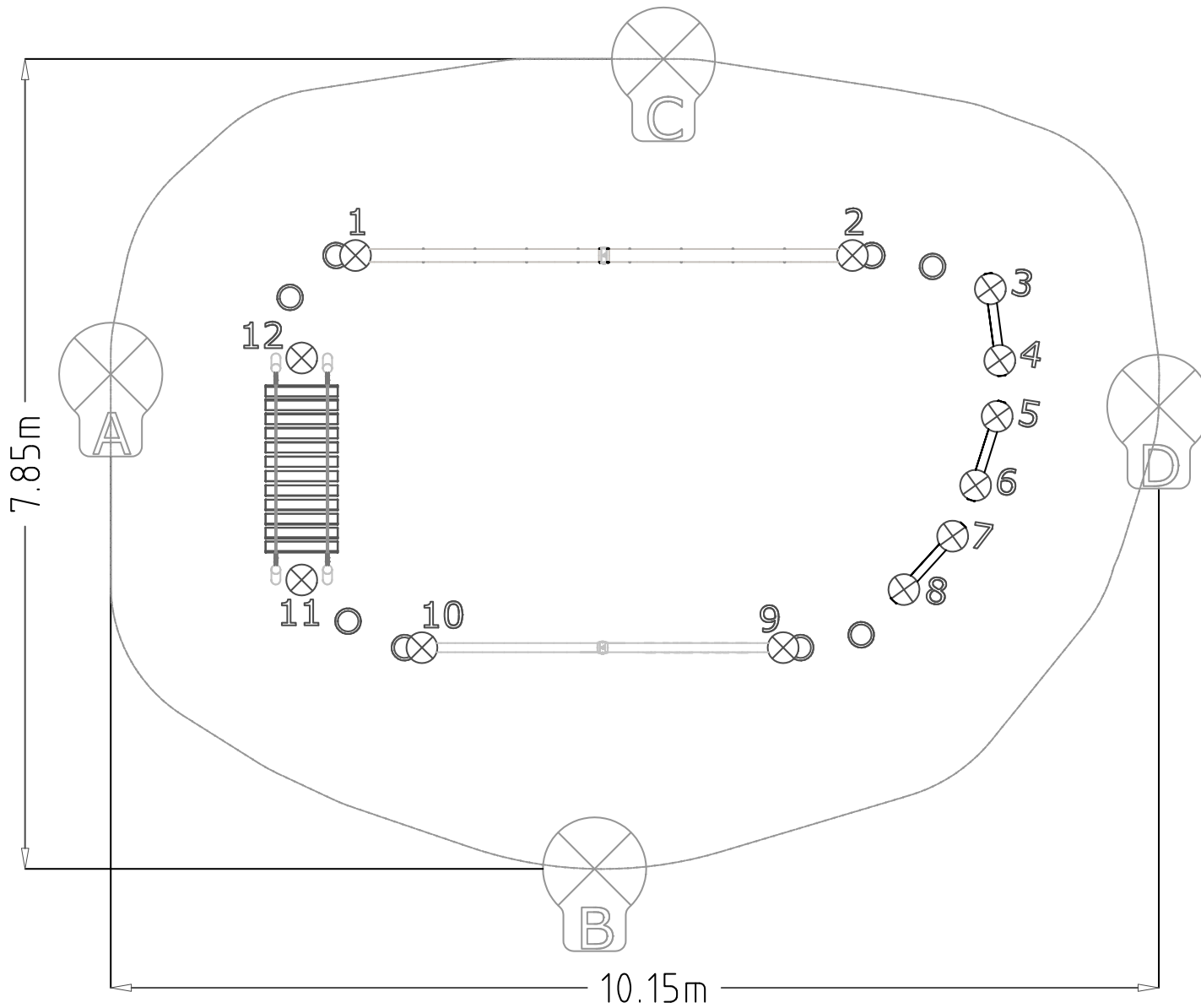
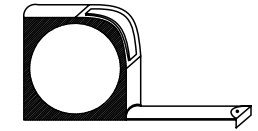

	A	B	C	D
A	0.00	6.70	6.16	10.16
B	6.70	0.00	7.87	7.07
C	6.16	7.87	0.00	5.86
D	10.16	7.07	5.86	0.00
1	2.64	6.38	3.54	7.92
2	7.55	6.75	3.31	3.87
3	8.79	7.09	4.36	2.82
4	8.61	6.30	4.38	1.60
5	8.60	5.87	4.74	1.57
6	8.45	5.24	5.12	1.93
7	8.31	4.74	5.41	2.36
8	7.96	4.04	5.64	3.04
9	7.31	3.45	6.15	4.77
10	4.01	2.72	6.16	7.51
11	2.75	4.01	6.16	8.48
12	1.86	5.71	4.55	8.32