

42008010

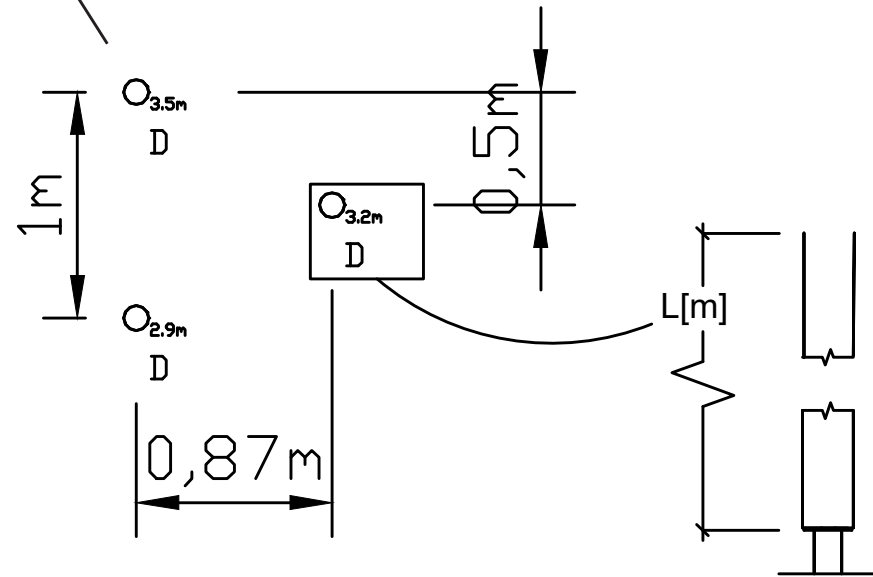

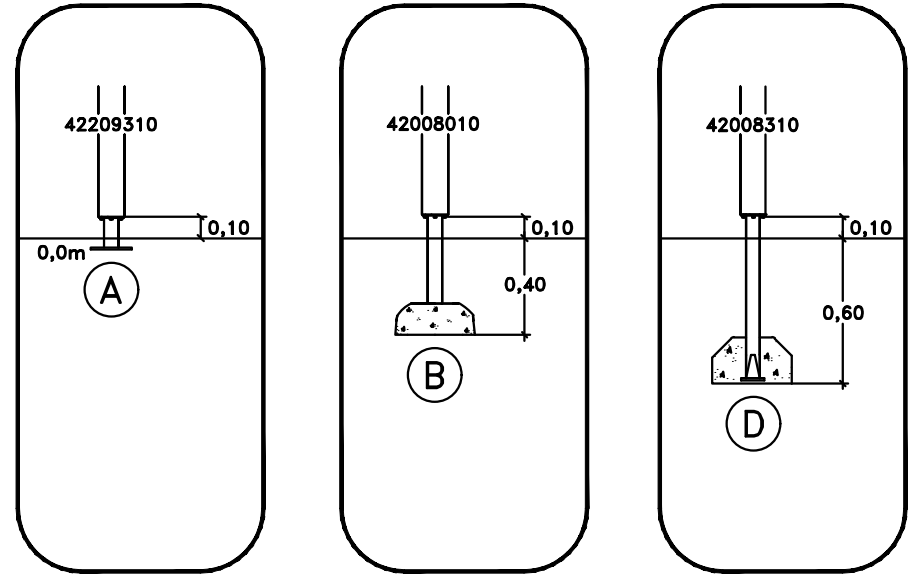
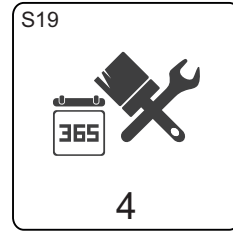
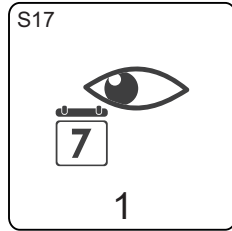
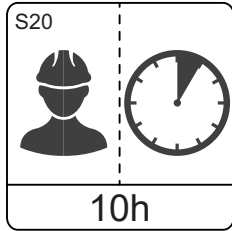
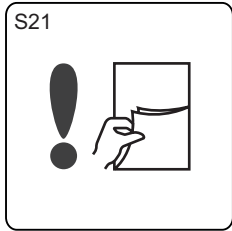

260329
426162
448000
42008010
42077010 [SF]
422212 [BM]
42277010 [OM]
423211 [SF]
424212 [OM]
42477010 [BM]
MA420994
MA45060520
MASW38904

42008010

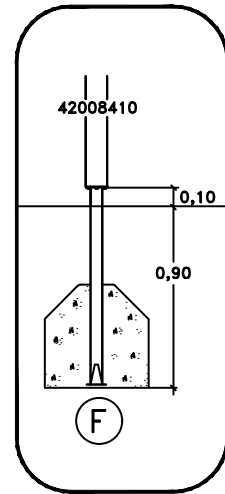
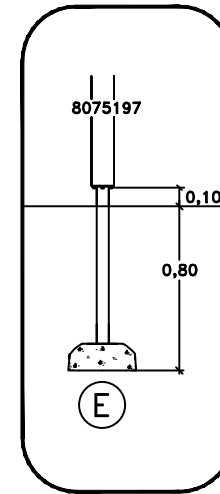
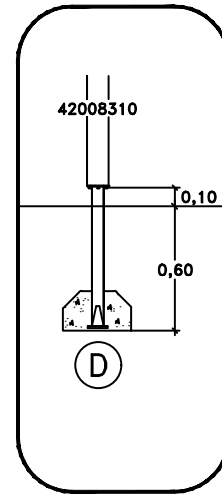
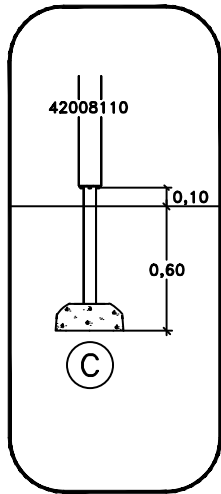
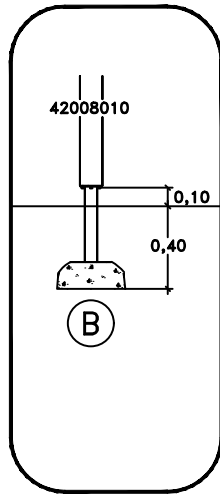
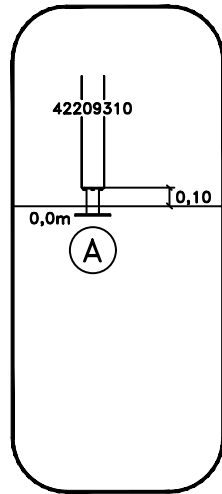

OM
Above Ground

8105787
80 _____
80 _____
80 _____
80 _____

SF
Sunken Foundation

8105784
80 _____
80 _____
80 _____
80 _____

CC
Cast In Place

8077978
8105788
80 _____
80 _____

BM
Loosefill

80 _____
80 _____
80 _____
80 _____

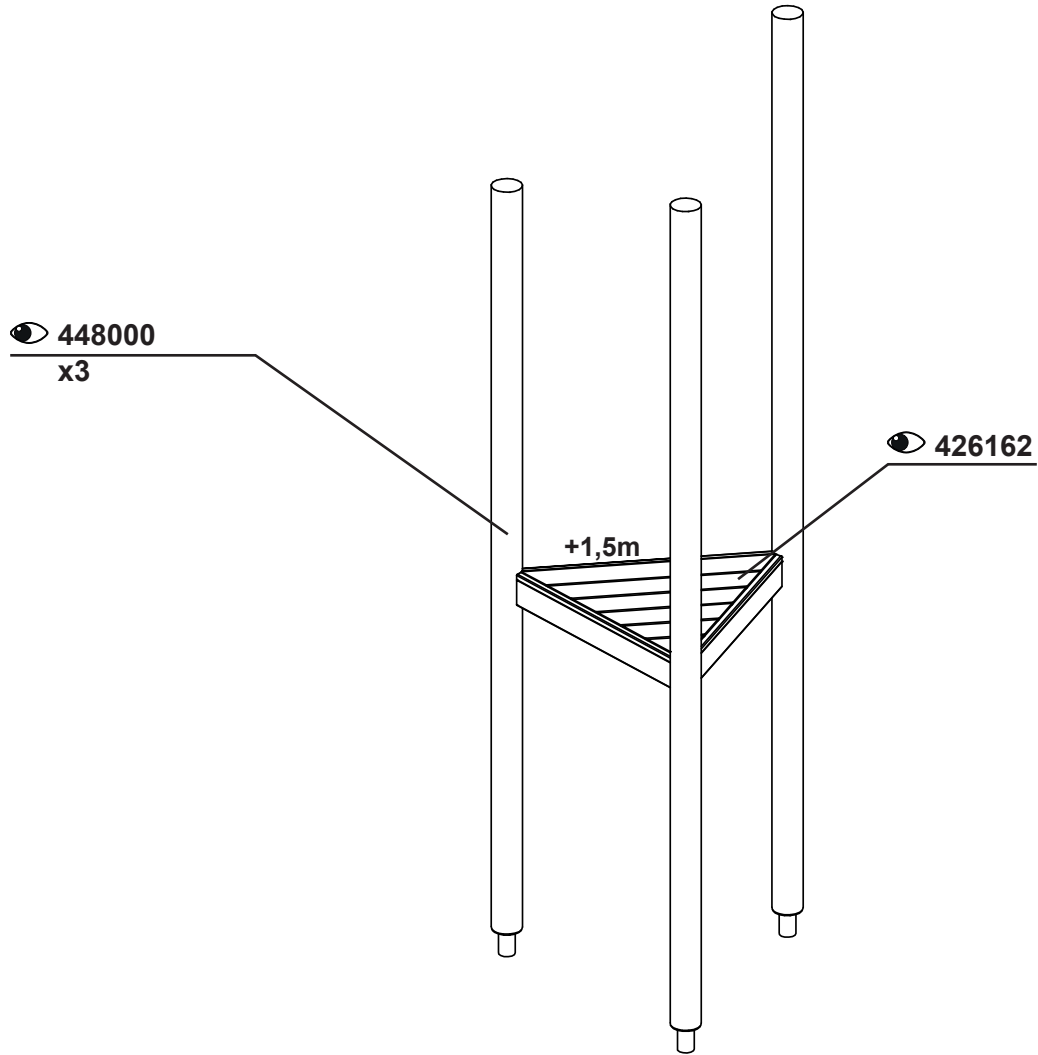
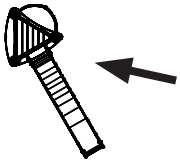

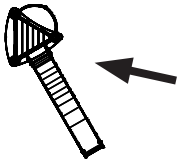

- 👁 423211 [SF]
- 👁 422212 [BM]
- 👁 424212 [OM]

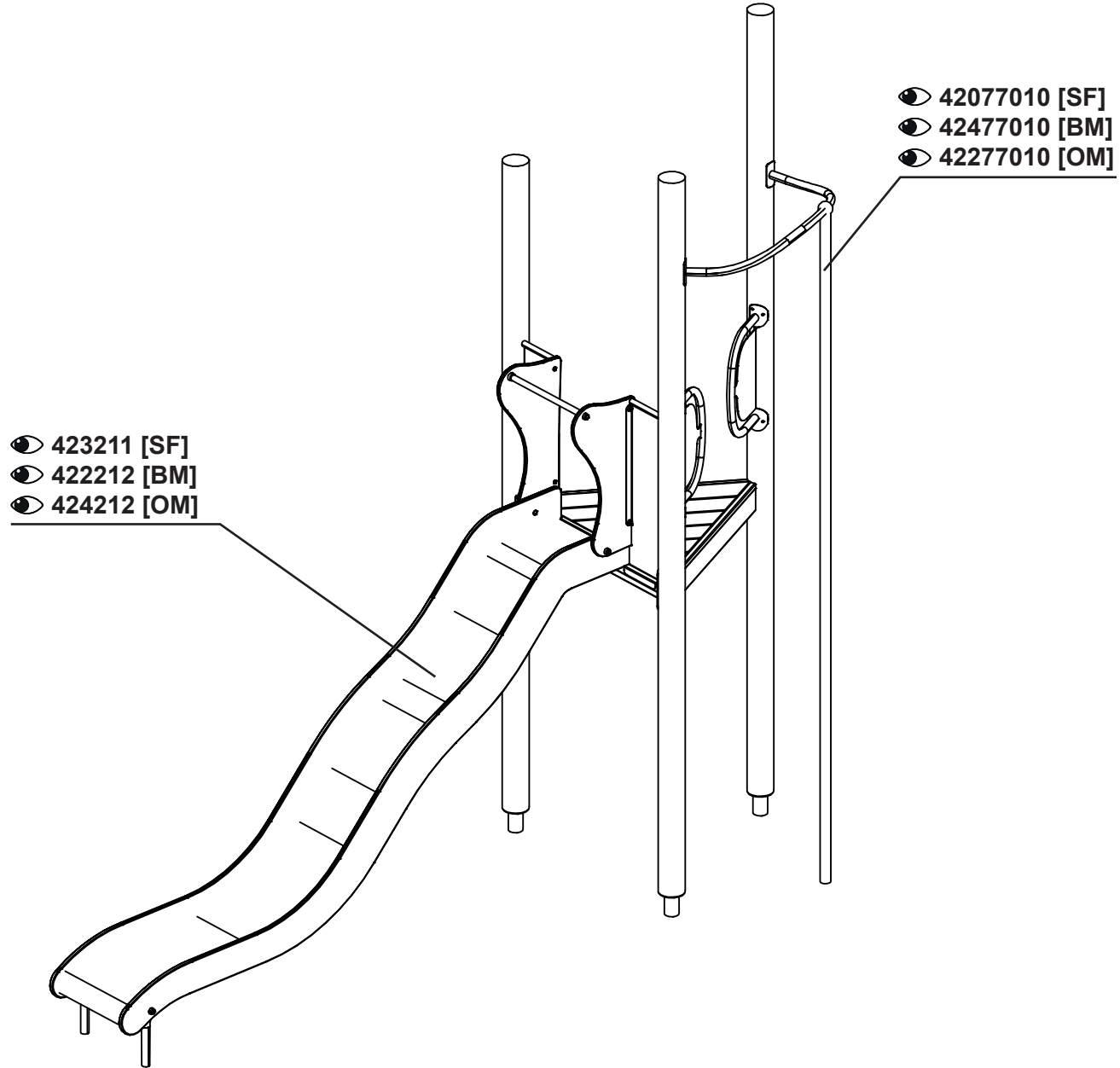

- 👁 42077010 [SF]
- 👁 42477010 [BM]
- 👁 42277010 [OM]

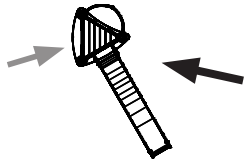

MA420994
x2

+1,00m

+0,60m

MA45060520
x2

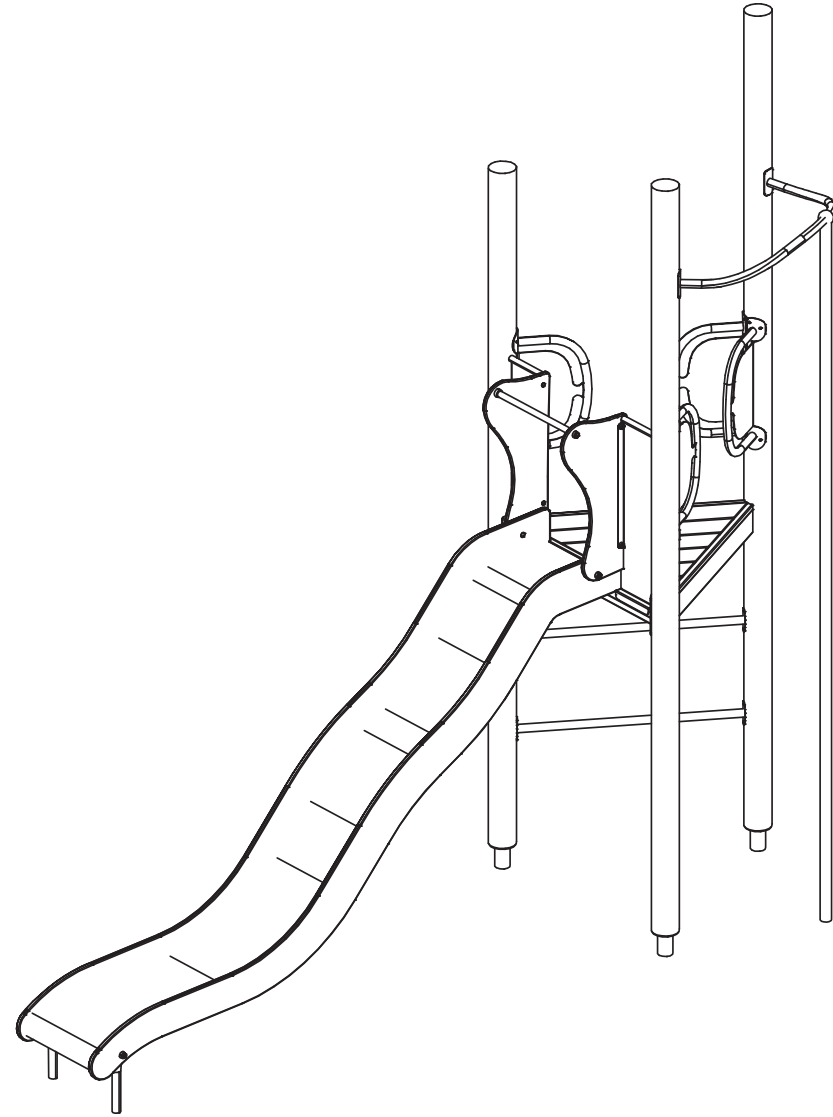

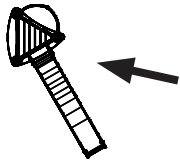

 MASW38904

 260329

